



5330 East 25th Street
Indianapolis Indiana 46218
Phone: (888) 445-4142
www.tepid.com

Installation &
Maintenance Manual
Certified to ANSI Z358.1



Stingray Systems S2240/S2540 Deck Mounted Swing Down Eye Wash

In order to comply with the ANSI Z358.1 Standard the following notes should be observed:

- Station should be assembled and installed in accordance with the manufacturer's instructions, including flushing fluid delivery requirements.
- Station should be in accessible locations that require no more than 10 seconds to reach. The eye/face wash station shall be located on the same level as the hazard and the path of travel shall be free of obstructions that may inhibit its immediate use.
- Station should be located in an area identified with a highly visible sign positioned so the sign shall be visible within the area served by the eye/face wash station. The area around the eye/face wash station shall be well-lit.
- Eye/Face wash shall be positioned with nozzles not less than 33 inches (83.8 cm) and no greater than 45 inches (114.3 cm) from surface on which user stands and 6 inches (15.3 cm) minimum from wall or nearest obstructions.
- If shut off valves are installed in the supply line for maintenance purposes, provisions shall be made to prevent unauthorized shut off.
- Refer to ANSI Z358.1 to ensure compliance.

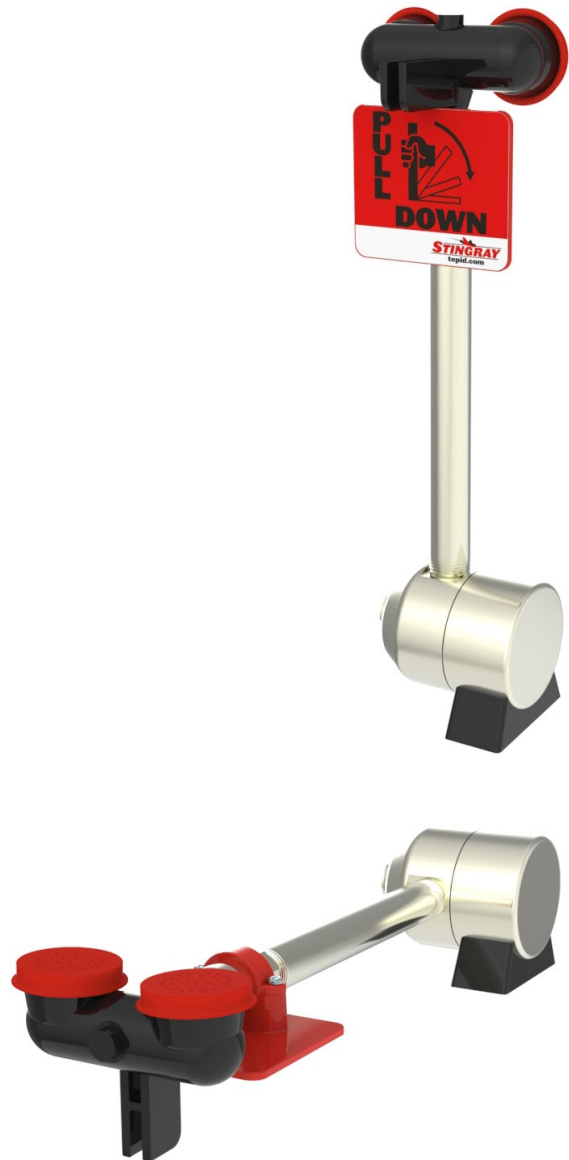

NOTES: It is recommended to flush pipes prior to installing emergency eyewash fixture. Instructions should be reviewed prior to starting the installation. Remove parts from packaging and verify all necessary parts are accounted for and not damaged. Please contact Stingray Systems for any missing or damaged parts prior to starting installation.

Stingray Systems recommends that you work safely at all times and in a manner consistent with the OSHA Lock/Tagout standard, 29 CFR 1910.147 and other applicable standards.

INSTALLATION SUPPLIES

Supplies Included:

- Pull down Eye or Eye/Face Wash Unit ✓
- Eye or Eye/Face Wash Block Assembly ✓
- Threaded Mounting Rods (2) ✓
- Mounting Nuts (2) ✓
- Mounting Washers (2) ✓
- Cradle Base ✓
- Gasket ✓

Supplies Required (Not Included):

- ½" NPT Piping Connection
- Pipe Sealant or Teflon Tape - To Be Used On All Piping Connections
- Blue Loctite Thread Locker

DECK MOUNT INSTALLATION

1. Use mounting pattern to locate and drill mounting holes (NOTE: **Gasket** and/or **Cradle Base** can also be used as template for locating mounting holes).
2. Apply Blue Loctite to one end of **Threaded Mounting Rods** and thread Mounting Rods into base as far as they will thread.
3. Slide **Cradle Base** and **Gasket** onto **Threaded Mounting Rods**. Verify that center holes of **Cradle Base** and **Gasket** align with ½" NPT hole of housing.
4. Insert assembly into mounting holes, oriented as shown, and secure using provided **Washers** and **Nuts** (NOTE: Excess length of **Mounting Rods** can be trimmed for clearance purposes).
5. Install ½" NPT piping connection through mounting assembly into housing of unit using pipe sealant at all connections. Installer to provide sufficient support of piping so that the assembled station is not relied on to supply support.
6. Insert **Eye or Eye/Face Wash Block** through paddle bracket into shark bite connection. Verify that Eye Block tangs align with tab of paddle.
7. Open water supply to unit and check for leaks. Pull unit down to activate and verify adequate water flow and drainage through **Eye or Eye/Face Wash Block**. Push unit back up to deactivate water flow. (NOTE: Standard mounting of unit places **Eye or Eye/Face Wash Block** over sink in activated position - trimming of **Eye or Eye/Face Wash Block** may be required if standard mounting not utilized.)
8. Mount sign near the assembled unit at the desired location.

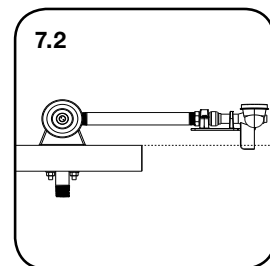
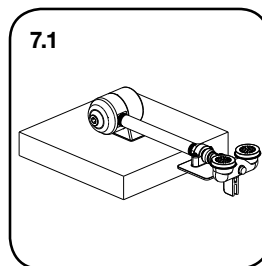
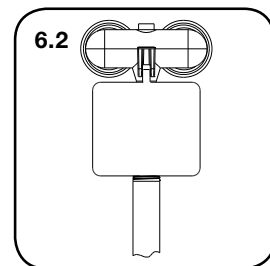
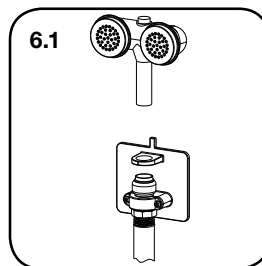
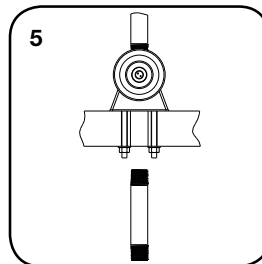
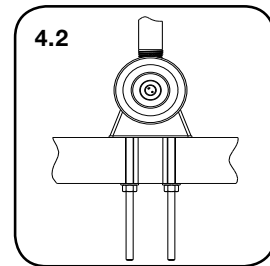
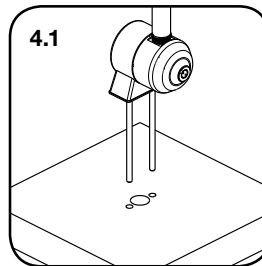
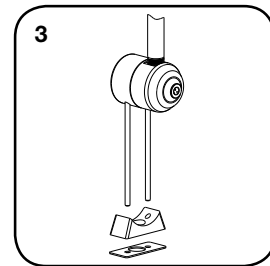
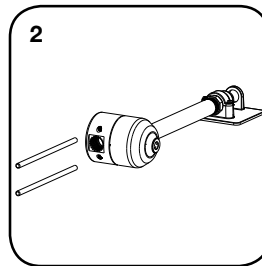
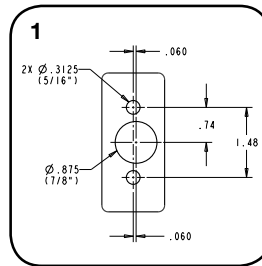



TROUBLESHOOTING

Problem	Checklist
No flow.	Make sure the water supply for station is on.
Water does not drain properly.	Check to see if station is installed level and correct as needed. Make sure nothing is blocking drain of the bowl. Remove any debris. Double check the main waste line for the facility. Make sure there is no blockage and that it can handle the required drainage.
Water leaks between fittings or connections.	Tighten all connections. If leak persist, disassemble, apply additional sealant and reassemble.
Insufficient flow to eye/face wash.	Turn water supply to station off. Remove the eye pieces and clean out any debris. Make sure diverter is fully opened. Verify pressure to station is at 30 psi as required.

MAINTENANCE

Emergency Eye/Face Wash System shall be activated on a weekly basis to verify operation and to flush the lines per the American National Standards Institute (ANSI). Inspections shall be recorded with inspector's name and date tested.

Should the need to repair or replace any parts on this station, please contact Stingray Systems. Before any repairs are performed, please verify that the water supply to the station is shut off.

GUARANTEE

We guarantee the Stingray Systems product to be free from defects in workmanship and material, and for a period of eighteen (18) months from date of shipment from the factory or one (1) year from date of installation, whichever occurs first, will replace any parts found by us to be defective. We will not be held responsible, however, for any labor incidental to, or for any damages caused by defective material.

With any questions, please do not hesitate in contacting us at: **1-888-445-4142** or via email at **info@tepid.com**.



WEEKLY TEST RECORD

Month	Test 1	Test 2	Test 3	Test 4
January				
February				
March				
April				
May				
June				
July				
August				
September				
October				
November				
December				
January				
February				
March				
April				
May				
June				
July				
August				
September				
October				
November				
December				

Plumbed emergency eyewashes, eye/face washes, drench hoses, shower, and combinations systems shall be activated and tested for a period long enough to verify operation and ensure that flushing fluid is available.

WARNING: This product contains chemicals known to the State of California to cause cancer and birth defects or other reproductive harm. (Installer: California law requires that this warning be given to the consumer.)
For more information: www.oehha.org/prop65